

Product Type: L-Angle
Product Definition: 075L075-33 33ksi
CSI Code: 09.22.16.13

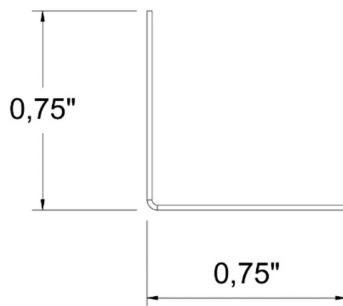

Profile Properties:

Web Depth	0,75 in	Yield Strength:	33 ksi
Flange Width	0,75 in	Cross Sectional Area	0,05 in ²
Design Thickness	0,0346 in	Unit Weight	0,1708 lb/ft
Minimum Thickness	0,0329 in	Finish	G40

Notes:

- Standard lengths: 10'-0", customs lengths are possible.
- Material with different yield strength and special coatings than the above are also possible.

Application Areas:

- Corner intersections
- Framing connections
- Half track connections

Codes & Standards:

- Calculations are based on AISI S220-20 and AISI S100-16.
- Complies with IBC2021, ASTM C645, ASTM C754, ASTM A653, ASTM A1003, ASTM E72
- LEED / Sustainability Credits: Environmental Product Declaration S-P Code: S-P-00869

